

# VistaView™

## **Installation Guide**

**Product tech. support:**

[support@wizardscreens.com](mailto:support@wizardscreens.com) 1-888-949-3667

## First things

- **READ INSTRUCTIONS BEFORE PROCEEDING.**
- It is recommended to install screens after door installation.
- If concealed, screen unit must be removable and serviceable.

## Unpackaging

- Unit and parts may be inspected at shop, but should be packaged when transiting to site.
- Closely inspect product for damage.
- **If there is damage, report to Wizard Screens with pictures immediately.**

## Preparation

- Ensure zippers are in housing endcap slots. **Figure 1**
- Do *not* remove 2 small track supports at top and bottom of pull bar *until* attaching the tracks. **Figure 2**
- Brakes must be *disengaged* when operating. Keep rivet pin in brake handle during installation. **Figure 3**

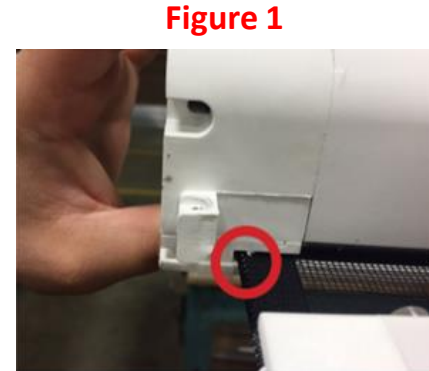

**Figure 1**

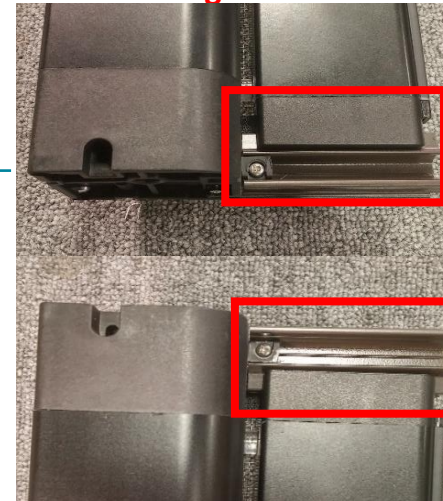

**Figure 2**

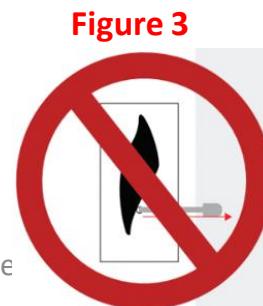

**Figure 3**

#8 Robertson Screwdriver



9/64 and 1/8 Drill Bits



#1 and #2 Robertson Driver Bits



Dry Silicone Spray



Small Countersink Bit



Utility Knife



Chop Saw

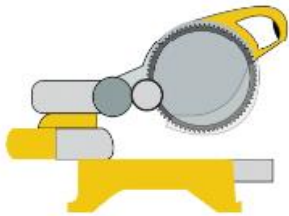

Drill



Step Ladder



Vacuum



Rubber Mallet



Level



Tape Measure

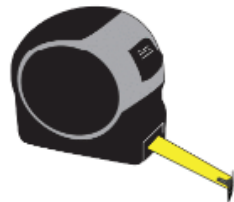

Pencil



Shims



**OPTIONAL**  
2-way Laser Level Kit



1. Maneuver housing into position and ensure plumb.
2. Mark endcap screw holes, move housing, and predrill 9/32" holes.
3. Affix housing with a housing screw at top (1).
4. For bottom (2), repeat steps 2 & 3. Ensure **plumb** and **free of twist**. Use shims if necessary.

\*NOTE: *Wait* to “drive home” the screws until *after* tracks are fastened to endcap nubs.

\*Brake rivet *must* remain in handle until the very end of installation.

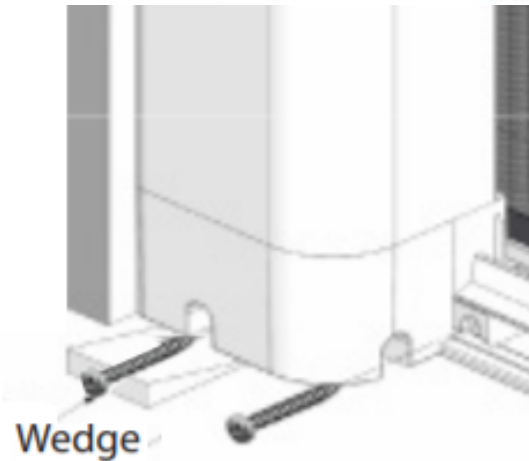
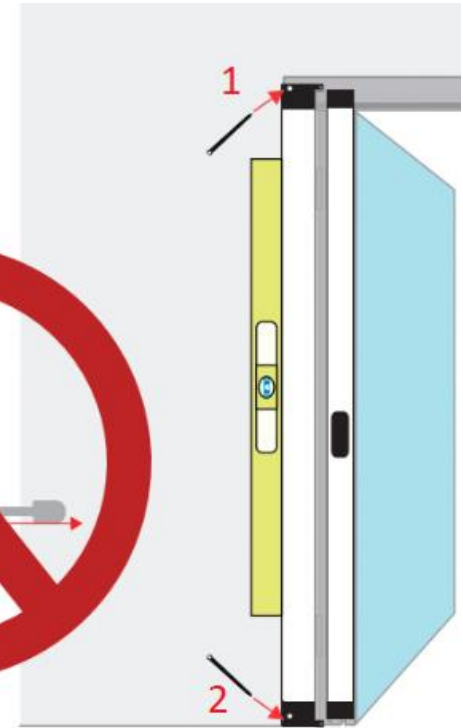

1. Onto **entry ends** of both tracks, countersink zipper path and de-burr.

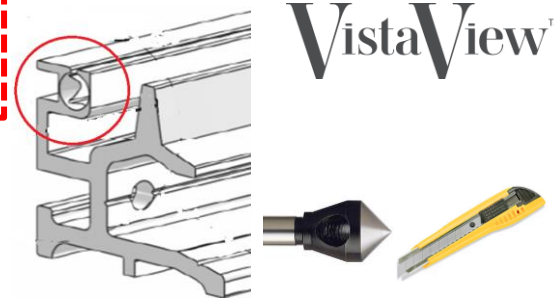

2. Mallet track guide onto **zipper entry end**.



3. Measure from **housing** to **opposite end** at the bottom, middle, and top. Record *smallest* measurement and mark on floor.

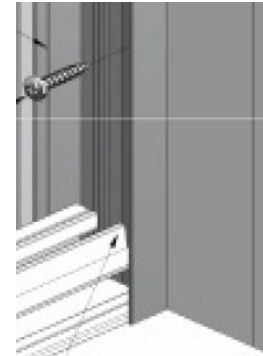
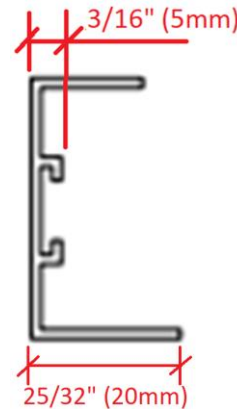

Track fits in as shown

4. Calculate final measurement:

- 1) Inside/Reveal: Subtract **3/16"**.
- 2) Surface: Add **25/32"**, then subtract **3/16"**.
- 3) Alternatively, position receiver at mark on floor.

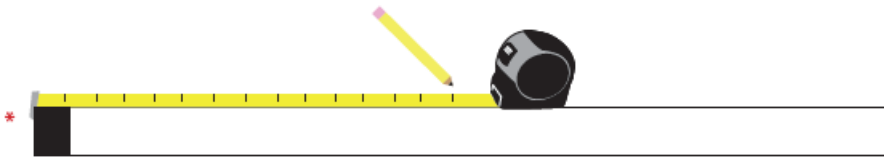

5.

6. Cut upper and bottom tracks to **identical length**.

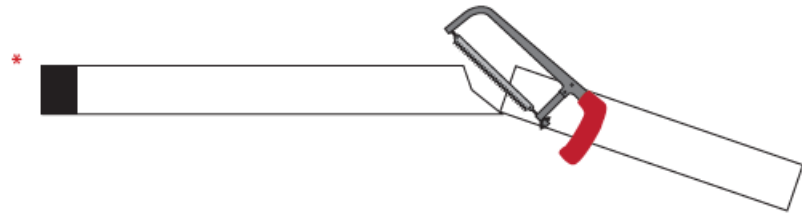

7. Pre-drill 1/8" holes @ 16" O/C into each track.

1. Onto **entry ends** of both tracks, countersink zipper path and de-burr.

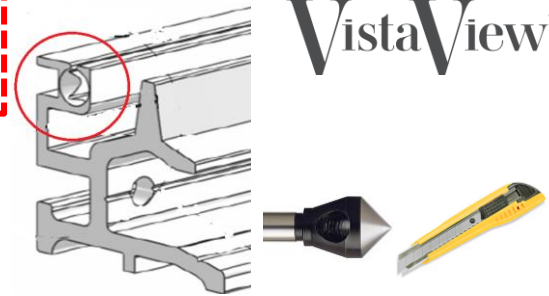

VistaView™



2. Mallet track guide onto **zipper entry end**.

3. Determine measurement from **housing to joint or end of corner** and record.

Straight Joiner



Internal Corner

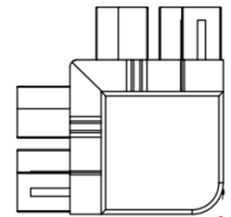

External Corner

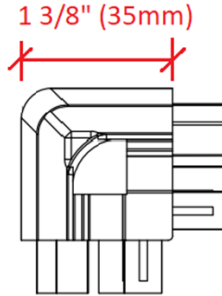

4. Calculate final measurement

- 1) **Straight:** Subtract **1/16"** to accommodate *straight* joiner.
- 2) **Corner:** Subtract **1 3/8"** to accommodate *corner* joiner.

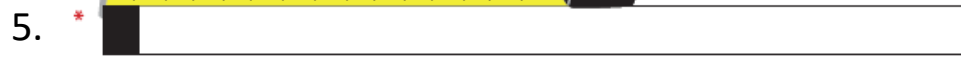

6. Cut upper and lower tracks to **identical length**. \*

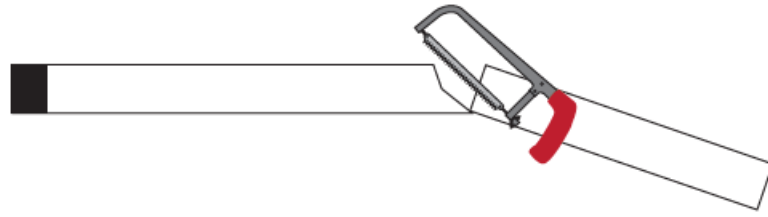

7. Repeat on other side.

8. Pre-drill 1/8" holes @ 16" O/C into each track.

1. Remove lower track support. Feed lower track along the pull bar endcap and zipper. Push track firm against the housing.

**Do not damage the zipper and mesh.**

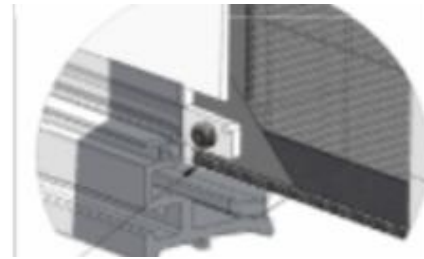

2. Fasten lower track to housing endcap nub, then fasten remainder of track **level**. Shim if necessary.
3. Repeat steps 1 & 2 for upper track.
4. “Drive home” the housing screws.
5. Bring the pull-bar to the nearest pre-drilled hole. Fasten upper track **1/8”** above pull bar. Fully retract, then draw to next hole. Repeat process until complete.
6. Singles: Position receiver against end of tracks and affix to surface  
(In-jamb mount shown).

**CHECK:**

Singles: Receiver and housing are **plumb** both ways.

Doubles: Housing and straight joiners/corner joiners are vertically aligned **plumb** both ways.

**Tracks level, parallel, and free of twist.**

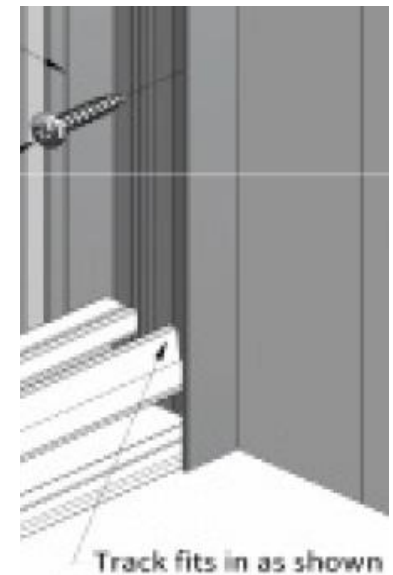

1. Attach cup to recess channel.
2. Position channel level. Shim if necessary.
3. Prep and cut tracks.
4. Prep track entry and mallet track-guide onto track
5. Fasten lower track-guide to housing endcap nub.
6. Place into the channel (may require 2 people).
7. Screw track into track channel.
8. Abide by standard steps otherwise where applicable.

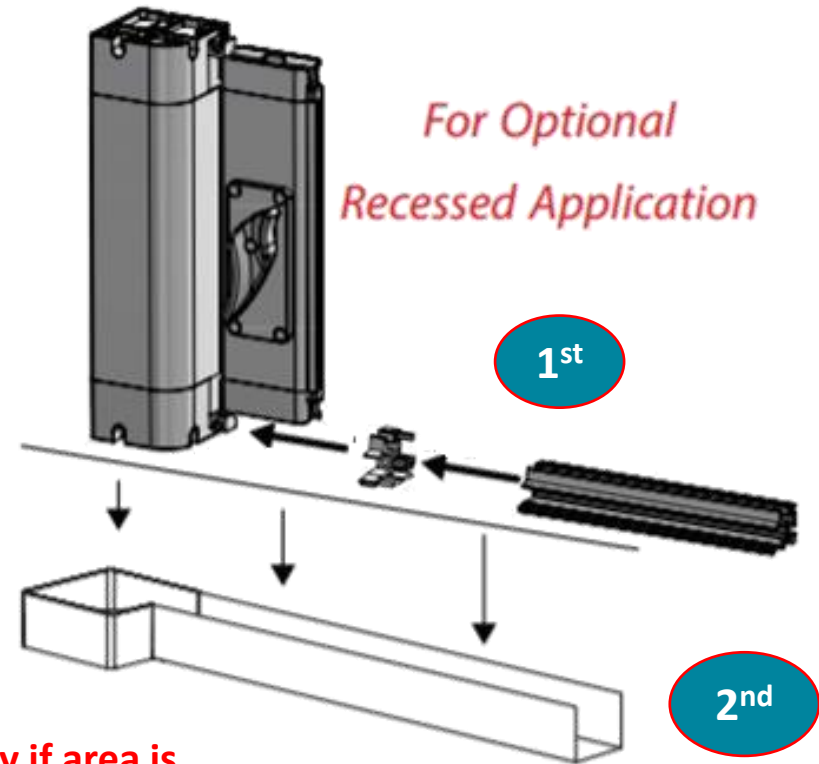

**\*\*IMPORTANT NOTE: For exterior applications, especially if area is unprotected, note that recess channel and tracks are not weatherproof. Water Egress is the responsibility of the general contractor or builder.**

See [Recessed Installation Video](#)



## Concealed Applications

- The VistaView *housing* and *upper track* should not be **concealed**. Otherwise, **ensure they can be removed easily** in the event the screen requires servicing. Do *not* embed the upper track into the header or ceiling. **It is the responsibility of the builder to develop removable trim work.** See [Recessed Installation Video](#)

## Exterior Applications

- **\*\*IMPORTANT NOTE:** For exterior applications, especially if area is unprotected, please note that recess channel and tracks are not weatherproof (see previous page). **Water Egress is the responsibility of the general contractor or builder.**
- If *lower tracks* are mounted on top of the threshold on the exterior where it is exposed to weather, it is recommended that **weep holes be drilled through the tracks.**

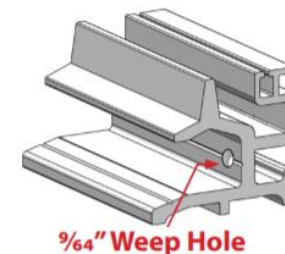

- If exposed to weather, it is good practice to dab pilot holes with waterproof silicone before fastening tracks, housing, and receiver.

Educate the homeowner:

1. Twist the brake handle **fully** when operating the screen.
2. Keep tracks clean with brush, cloth, or vacuum every so often **especially with exterior mounts**. Mesh may be vacuumed with upholstery brush.

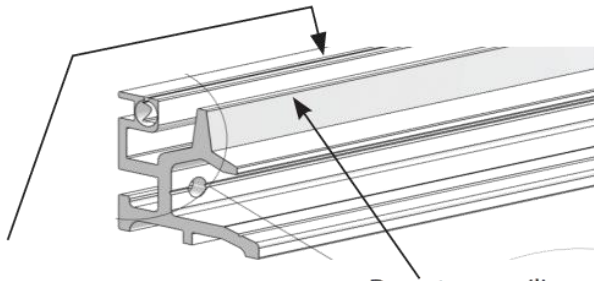

3. Spray Silicone into the opening that the mesh slides in along the entire track. Do not spray silicone where the brake is applied. Use **only dry silicone**. Frequency dependent upon season and location. Clean tracks first.
4. Do **not** use corrosive cleaners.
5. Retract when not in use.

